

FJMA790

PNP Epitaxial Silicon Transistor

High current surface mount PNP silicon switching transistor for load management in portable applications

- High Collector current
- Low Collector-Emitter Saturation Voltage
- RoHS Compliant

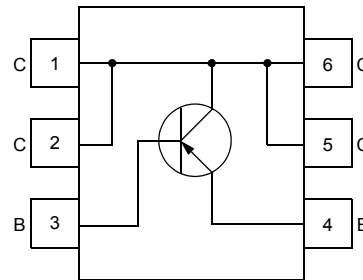
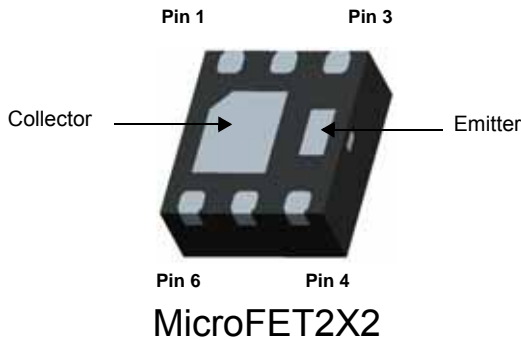

Absolute Maximum Ratings $T_a = 25^\circ\text{C}$ unless otherwise noted

Symbol	Parameter	Value	Units	
V_{CBO}	Collector-Base Voltage	-50	V	
V_{CEO}	Collector-Emitter Voltage	-35	V	
V_{EBO}	Emitter-Base Voltage	-5	V	
I_C	Collector Current (DC)	-2	A	
P_D	Power Dissipation	Note1)	1.56	W
		Note2)	0.8	W
T_J	Junction Temperature	150	$^\circ\text{C}$	
T_{STG}	Storage Temperature	-55 ~ 150	$^\circ\text{C}$	

Thermal Characteristics $T_a=25^\circ\text{C}$ unless otherwise noted

Symbol	Parameter	Max.	Units	
$R\Theta_{JA}$	Thermal Resistance, Junction to Ambient	Note1)	80	$^\circ\text{C/W}$
		Note2)	154	$^\circ\text{C/W}$

Note1): The device mounted on a 1inch² pad of 2 oz copper pad on a 1.5 × 1.5 in. board of FR-4 material.

Note2): The device mounted on a minimum pad of 2 oz copper pad on a 1.5 × 1.5 in. board of FR-4 material

Electrical Characteristics $T_a = 25^\circ\text{C}$ unless otherwise noted

Symbol	Parameter	Conditions	Min.	Typ.	Max.	Units
BV_{CBO}	Collector-Base Breakdown Voltage	$I_C = -100\mu\text{A}, I_E = 0$	-50			V
BV_{CEO}	Collector-Emitter Breakdown Voltage	$I_C = -10\text{mA}, I_B = 0$	-35			V
BV_{EBO}	Emitter-Base Breakdown Voltage	$I_C = -100\mu\text{A}, I_C = 0$	-5			V
I_{CBO}	Collector Cut-off Current	$V_{CB} = -35\text{V}, I_C = 0$			-0.1	μA
I_{EBO}	Emitter Cut-off Current	$V_{EB} = -4\text{V}, I_C = 0$			-0.1	μA
h_{FE}	DC Current Gain	$V_{CE} = -1.5\text{V}, I_C = -1\text{A}$ $V_{CE} = -1.5\text{V}, I_C = -1.5\text{A}$ $V_{CE} = -3\text{V}, I_C = -2\text{A}$ $V_{CE} = -2\text{V}, I_C = -500\text{mA}$	100 100 100 100		400	
$V_{CE(sat)}$	Collector-Emitter Saturation Voltage	$I_C = -500\text{mA}, I_B = -5\text{mA}$ $I_C = -1\text{A}, I_B = -10\text{mA}$ $I_C = -2\text{A}, I_B = -50\text{mA}$			-250 -350 -450	mV mV mV
$V_{BE(sat)}$	Base-Emitter Saturation Voltage	$I_C = -1\text{A}, I_B = -10\text{mA}$			-0.9	V
$V_{BE(on)}$	Base-Emitter On Voltage	$V_{CE} = -2\text{V}, I_C = -1\text{A}$			-0.9	V

Package Marking and Ordering Information

Device Marking	Device	Package	Reel Size	Tape Width	Quantity
790	FJMA790	MLP 2x2 Single	7"	8mm	3,000 units

Typical Characteristics

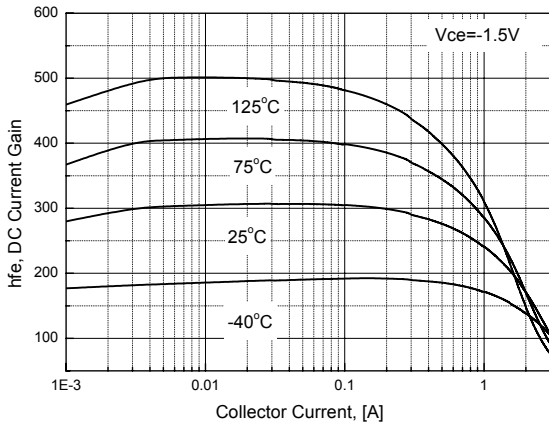

Figure 1. DC Current Gain, Vce=1.5V

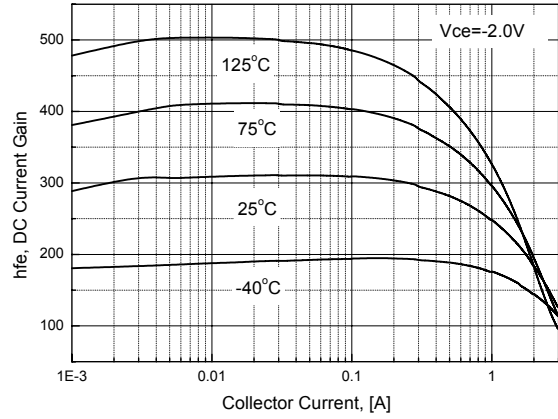

Figure 2. DC Current Gain, Vce=2V

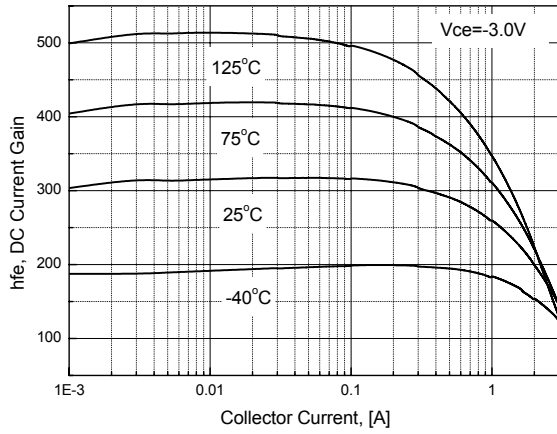

Figure 3. DC Current Gain, Vce=3V

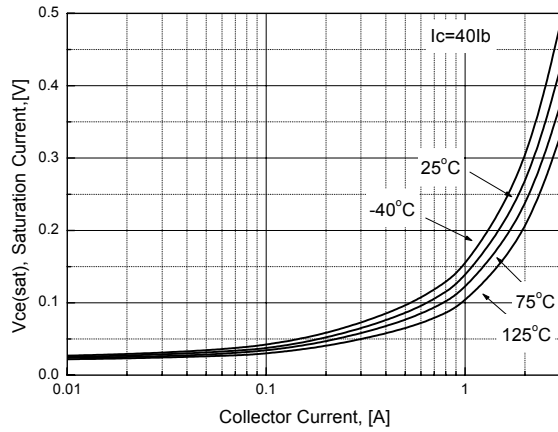

Figure 4. Collector-Emitter Saturation Voltage(1)

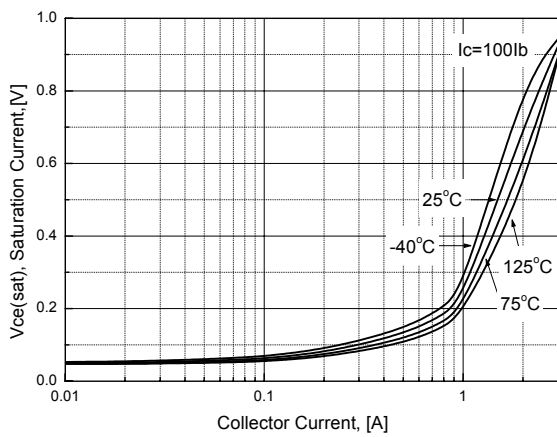

Figure 5. Collector-Emitter Saturation Voltage(2)

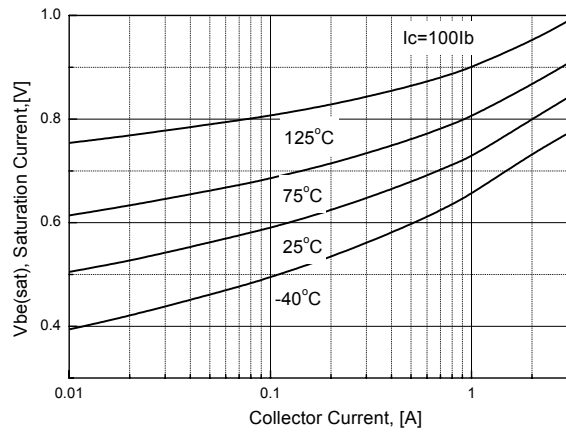

Figure 6. Base-Emitter Saturation Voltage

Typical Performance Characteristics (Continued)

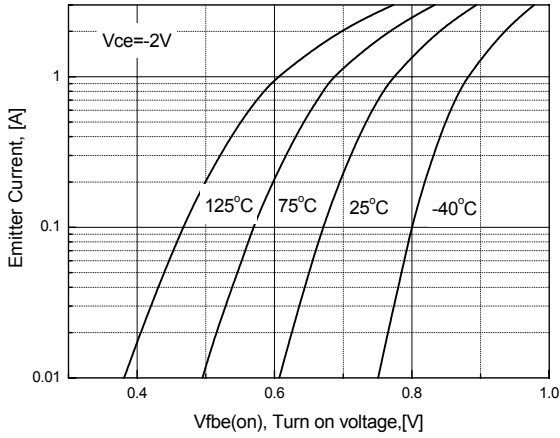

Figure 7. Base-Emitter Turn On Voltage

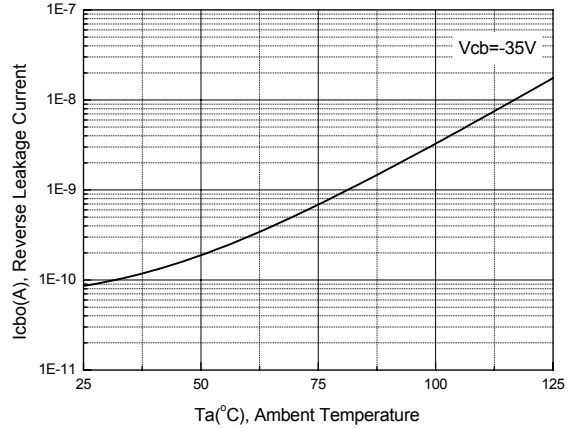

Figure 8. Collector-Base Leakage Current

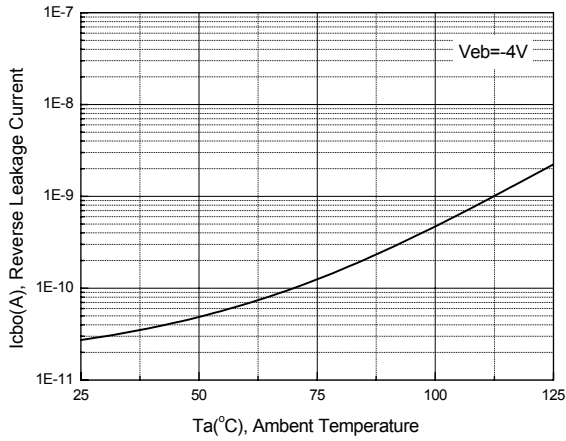

Figure 9. Base-Emitter Leakage Current

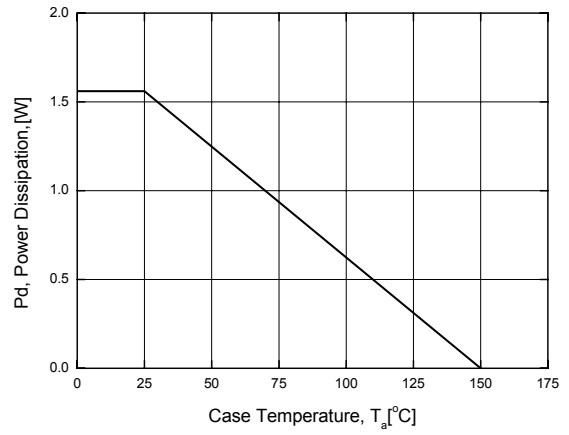

Figure 10. Power Derating

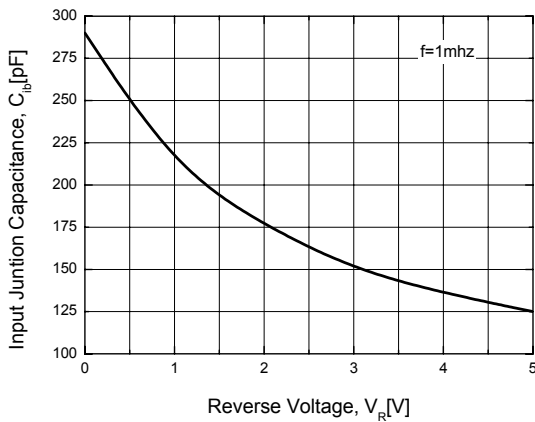

Figure 11. Input Capacitance

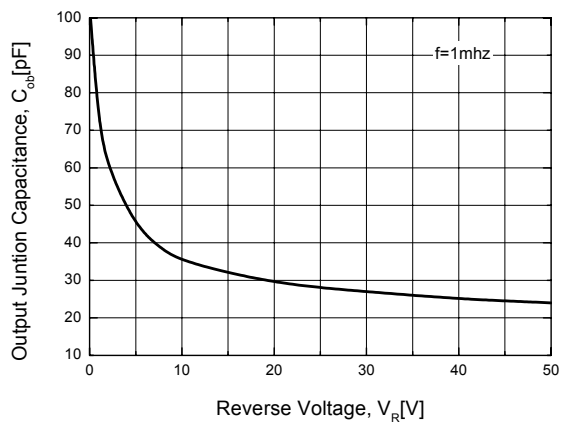
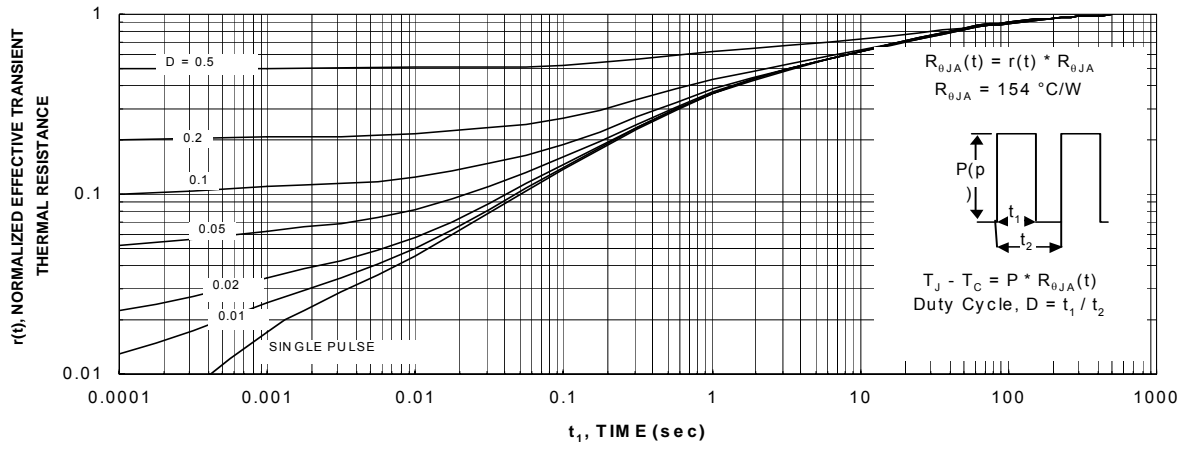

Figure 12. Output Capacitance

Typical Performance Characteristics (Continued)

Figure 12. Transient Thermal Response



Mechanical Dimensions

MicroFET2X2

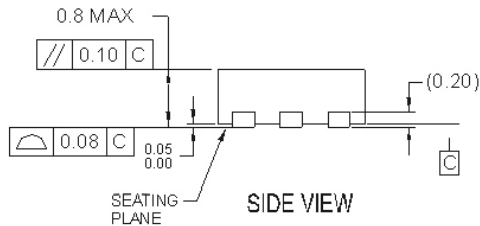
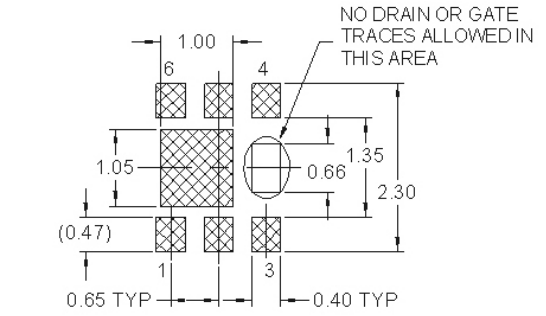
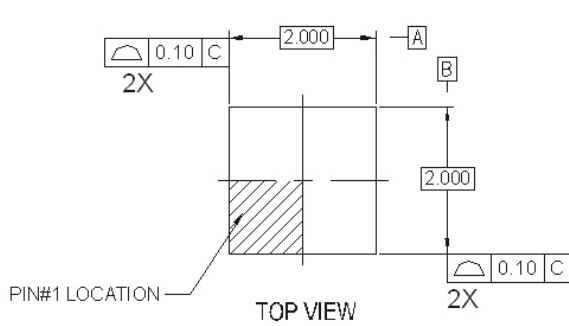

RECOMMENDED LAND PATTERN OPT 1

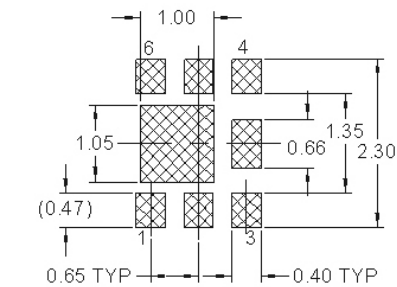
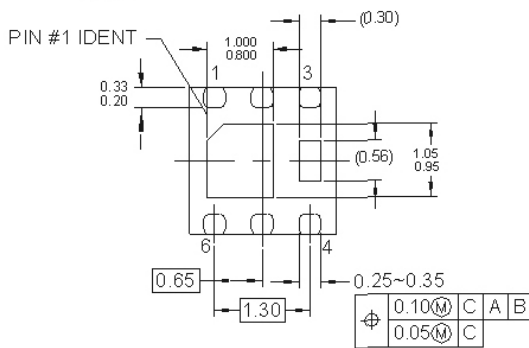

NOTES:

- A. DOES NOT FULLY CONFORM TO JEDEC REGISTRATION MO-229 DATED AUG/2003
- B. DIMENSIONS ARE IN MILLIMETERS.
- C. DIMENSIONS AND TOLERANCES PER ASME Y14.5M, 1994
- D. DRAWING FILENAME: MKT-MLP06Lrev2.

Dimensions in Millimeters



TRADEMARKS

The following includes registered and unregistered trademarks and service marks, owned by Fairchild Semiconductor and/or its global subsidiaries, and is not intended to be an exhaustive list of all such trademarks.

- | | | | |
|---|---|---|---|
| ACEx [®] | FPS [™] | PDP-SPM [™] | The Power Franchise [®] |
| Build it Now [™] | F-PFS [™] | Power-SPM [™] | the power
franchise |
| CorePLUS [™] | FRFET [®] | PowerTrench [®] | TinyBoost [™] |
| CorePOWER [™] | Global Power Resource SM | Programmable Active Droop [™] | TinyBuck [™] |
| CROSSVOLT [™] | Green FPS [™] | QFET [®] | TinyLogic [®] |
| CTL [™] | Green FPS [™] e-Series [™] | QS [™] | TINYOPTO [™] |
| Current Transfer Logic [™] | GTO [™] | Quiet Series [™] | TinyPower [™] |
| EcoSPARK [®] | IntelliMAX [™] | RapidConfigure [™] | TinyPWM [™] |
| EfficientMax [™] | ISOPLANAR [™] | Saving our world 1mW at a time [™] | TinyWire [™] |
| EZSWITCH [™] * | MegaBuck [™] | SmartMax [™] | μSerDes [™] |
|  ™ | MICROCOUPLER [™] | SMART START [™] |  |
|  ™ | MicroFET [™] | SPM [®] | UHC [®] |
| Fairchild [®] | MicroPak [™] | STEALTH [™] | Ultra FRFET [™] |
| Fairchild Semiconductor [®] | MillerDrive [™] | SuperFET [™] | UniFET [™] |
| FACT Quiet Series [™] | MotionMax [™] | SuperSOT [™] -3 | VCX [™] |
| FACT [®] | Motion-SPM [™] | SuperSOT [™] -6 | VisualMax [™] |
| FAST [®] | OPTOLOGIC [®] | SuperSOT [™] -8 | |
| FastvCore [™] | OPTOPLANAR [®] | SuperMOS [™] | |
| FlashWriter [®] * |  ™ |  | |

* EZSWITCH[™] and FlashWriter[®] are trademarks of System General Corporation, used under license by Fairchild Semiconductor.

DISCLAIMER

FAIRCHILD SEMICONDUCTOR RESERVES THE RIGHT TO MAKE CHANGES WITHOUT FURTHER NOTICE TO ANY PRODUCTS HEREIN TO IMPROVE RELIABILITY, FUNCTION, OR DESIGN. FAIRCHILD DOES NOT ASSUME ANY LIABILITY ARISING OUT OF THE APPLICATION OR USE OF ANY PRODUCT OR CIRCUIT DESCRIBED HEREIN; NEITHER DOES IT CONVEY ANY LICENSE UNDER ITS PATENT RIGHTS, NOR THE RIGHTS OF OTHERS. THESE SPECIFICATIONS DO NOT EXPAND THE TERMS OF FAIRCHILD'S WORLDWIDE TERMS AND CONDITIONS, SPECIFICALLY THE WARRANTY THEREIN, WHICH COVERS THESE PRODUCTS.

LIFE SUPPORT POLICY

FAIRCHILD'S PRODUCTS ARE NOT AUTHORIZED FOR USE AS CRITICAL COMPONENTS IN LIFE SUPPORT DEVICES OR SYSTEMS WITHOUT THE EXPRESS WRITTEN APPROVAL OF FAIRCHILD SEMICONDUCTOR CORPORATION.

As used herein:

- Life support devices or systems are devices or systems which, (a) are intended for surgical implant into the body or (b) support or sustain life, and (c) whose failure to perform when properly used in accordance with instructions for use provided in the labeling, can be reasonably expected to result in a significant injury of the user.
- A critical component in any component of a life support, device, or system whose failure to perform can be reasonably expected to cause the failure of the life support device or system, or to affect its safety or effectiveness.

PRODUCT STATUS DEFINITIONS

Definition of Terms

Datasheet Identification	Product Status	Definition
Advance Information	Formative or In Design	This datasheet contains the design specifications for product development. Specifications may change in any manner without notice.
Preliminary	First Production	This datasheet contains preliminary data; supplementary data will be published at a later date. Fairchild Semiconductor reserves the right to make changes at any time without notice to improve design.
No Identification Needed	Full Production	This datasheet contains final specifications. Fairchild Semiconductor reserves the right to make changes at any time without notice to improve the design.
Obsolete	Not In Production	This datasheet contains specifications on a product that is discontinued by Fairchild Semiconductor. The datasheet is for reference information only.

Rev. I34